

論文 (Original Article)

Change in Revolution Speeds of Band Saw Wheels and Power Consumption During Sawing

MURATA Kohji^{1)*}, IKAMI Yuji¹⁾ and FUJIWARA Katsutoshi¹⁾

Abstract

It is said that the revolution speeds of band saw wheels change during sawing by the load acting on the band saw. However, there are few quantitative data on such change during sawing. In this study, the revolution speeds of the band saw wheels were measured precisely with rotary encoders, in order to examine the influence of sawing condition on the change in revolution speed and the power consumption during sawing. The revolution speeds of band saw wheels decreased along with the start of sawing, and then it resumed closely to the idling revolution speed level. It increased immediately after sawing and then it came down to the idling revolution speed level before sawing. The power consumption increased rapidly simultaneous with the start of sawing and then it decreased gently. After sawing, the power consumption decreased rapidly and then resumed the level for idling. The differences between the maximum and minimum revolution speeds of band saw wheels during sawing increased with an increase in feed speed and also with an increase in depth of workpiece.

Key words: band saw, band saw wheel, revolution speed, power consumption, change in revolution speed

1. Introduction

It is important to grasp the behavior of revolution speed of band saw wheels and power consumption in order to clarify the behavior of band saw during sawing. It is said that the revolution speeds of band saw wheels change resulted from the load acting on the band saw during sawing. For example, the revolution speed of band saw wheel was reported to decrease 5 % during sawing 19 cm thick Buna (*Fagus crenata* Blume) lumber with a table band re-saw (Yamaguchi and Mori, 1957). However, there are few detailed data on the change in revolution speed of band saw wheels during sawing.

The power consumption is one of the indexes of sawing property. It is well known that the power consumption of the main motor is greater during sawing than during idling in band sawing (Sugihara, 1954A). Sugihara reported that the power consumption increased with an increase in cutting speed (Sugihara, 1954B). It is reported that the net power consumption increased linearly with an increase in depth of cut of workpiece in band sawing (Konishi and Yamaguchi, 1978). Murata, Fujiwara, and Nishimura reported that the net power consumption increased with an increase in feed speed and with a decrease in revolution speed of band saw wheels (Murata, Fujiwara, and Nishimura, 1993). However, there is no report that examines the change in

power consumption of the main motor in band sawing.

The objective of this study is to examine the influence of some sawing conditions on the change in revolution speed of band saw wheels and power consumption during sawing.

2. Experiment

Fig.1 shows the schematic diagram of the experimental set-up for the measurement of revolution speeds of band saw wheels. A band mill with a light auto-feed carriage was used in this study. The diameter of its band saw wheels was 1100 mm and the rated power of its main motor with an inverter was 22 kW. The revolution speeds of upper and lower band saw wheels were detected with the rotary encoders installed on their axes. The data of the revolution speeds of band saw wheels were inputted into a computer in real time through frequency/rate meters and a data acquisition card. The power consumption of the main motor for the band mill was measured with a power meter and its data was also inputted into the computer in real time. The sampling interval for the revolution speeds of band saw wheels and the power consumption was 0.2 sec.

The workpiece was 2 m long green lumber from Malas (*Homalium foetidum* Benth). Its average density was 795kg/m³ in oven dry condition. The band saw used

原稿受付：平成14年4月16日 Received Apr. 16, 2002 原稿受理：平成14年5月16日 Accepted May 16, 2002

* Department of Wood processing, Forestry and Forest Products Research Institute, P.O.Box16, Tsukuba Norin Kenkyu Danchi-nai, Ibaraki 305-8687, Japan; e-mail:saw@ffpri.affrc.go.jp

1) Department of Wood processing, Forestry and Forest Products Research Institute

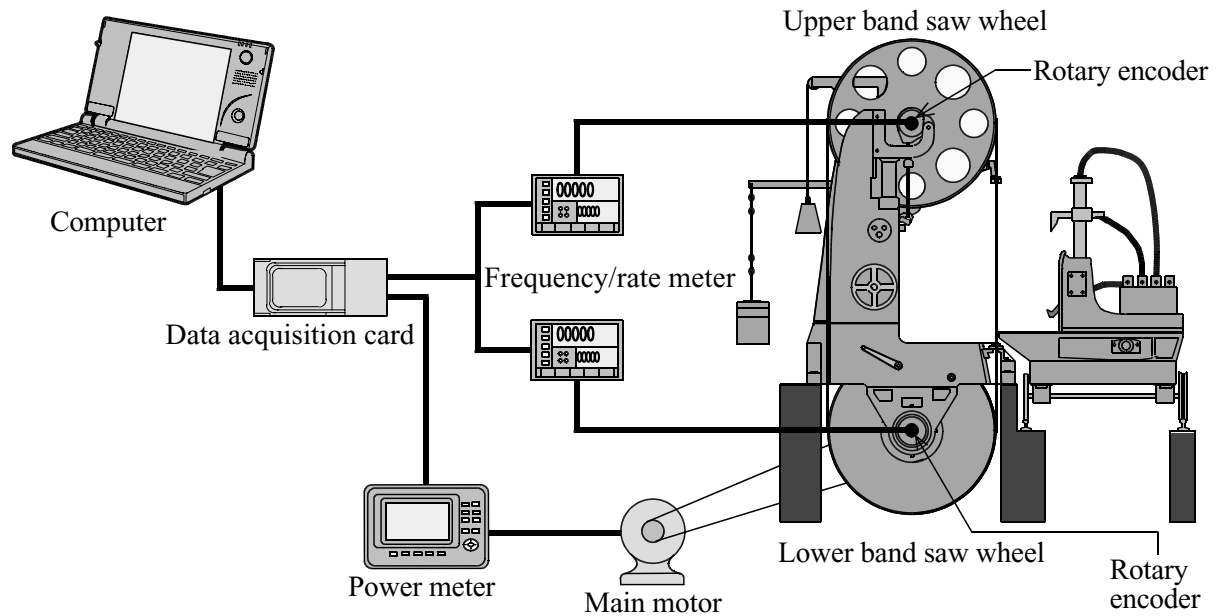

Fig.1. Schematic diagram of experimental set-up for the measurement of revolution speeds of band saw wheels.

was 126 mm in width, 1.05 mm in thickness, 32 mm in pitch, 220 in number of teeth, 1.96 mm in kerf width, 25 degrees in rake angle, and 45 degrees in sharpness angle. The band saw teeth were tipped with stellite. The experimental condition is summarized in Table 1. In this paper, the set point of revolution speed of band saw wheel, namely nominal idling revolution speed of band saw wheel, is abbreviated to SPRS.

3. Results and Discussion

3.1. Behavior of revolution speed of band saw wheel and power consumption during sawing

Fig.2 and 3 show the behavior of revolution speeds of band saw wheels and power consumption at each SPRS and at each feed speed, respectively. The revolution speed of the upper band saw wheel was slightly greater than that of the lower one as shown in Fig. 2. This was mainly resulted from the difference between circumferences of the upper and lower band saw wheels. The net circumferences of the upper and lower band saw wheels were 3456.5 and 3461.5 mm, respectively: the ratio of the latter to the former was 1.001. The mean of the ratio of the revolution speed of

the lower band saw wheel to that of the upper one was also 1.001 under the all sawing conditions and corresponded to the ratio of the circumference of the upper one to that of the lower one.

The revolution speeds of the two wheels were almost constant during idling. The revolution speeds decreased along with the start of sawing and then resumed the idling revolution speed level, namely the set point. After sawing the revolution speeds increased immediately and then reached to the idling revolution speed level before sawing.

The power consumption increased rapidly simultaneous with the start of the sawing and then gradually decreased. After sawing, it decreased rapidly and then resumed the idling power consumption level. The load acting on the band saw should increase along with the start of the sawing; consequently, the revolution speeds of band saw wheels decreased, and the net power consumption increased. While the revolution speeds increased to the set point, the power consumption gradually decreased after reaching the maximum. Because the load acting on the band saw is removed simultaneous with the finish of sawing, the revolution

Table 1. Experimental condition.

Factors		Levels		
SPRS	(rpm)	550	650	750
Feed speed	(m/min)	22.9	36.2	43.9
Saw strain	(GPa)	76.4	81.3	94.1

SPRS : Set point of revolution speed of band saw wheel

speeds increased immediately after the finish of sawing.

It is also apparent from Fig.2 and 3 that there was a time lag between the response of the revolution speeds of band saw wheels and the power consumption. The time lag was 0.2 or 0.4 sec under each sawing condition.

This time lag may lead to increase the revolution speeds after finish of sawing: the load acting on the band saw is removed immediately after finish of sawing but the electric current still flows much as sawing level through main motor for a while, so that the revolution speeds

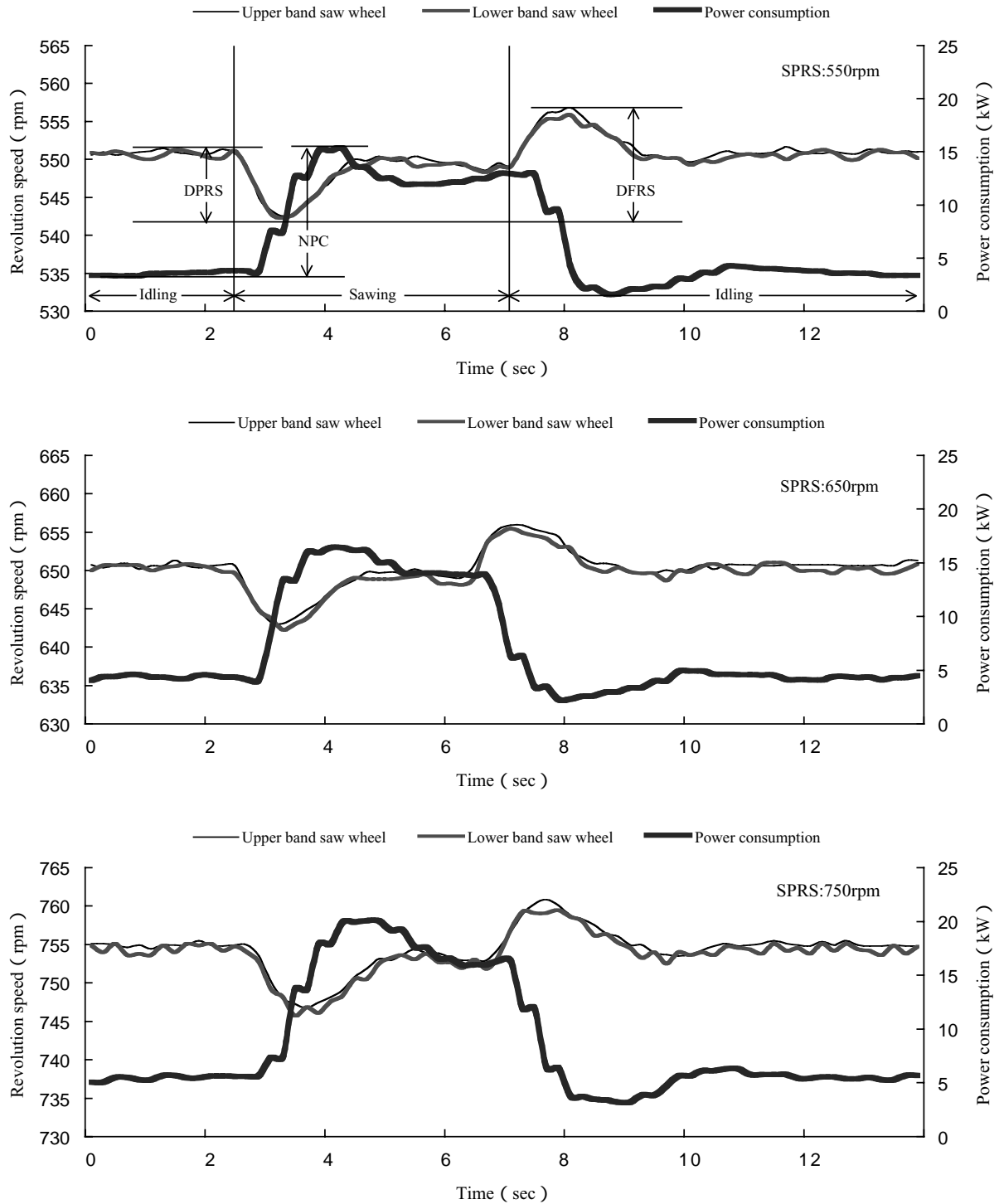

Fig.2. Behavior of revolution speeds of band saw wheels and power consumption at each SPRS.
 Saw strain : 81.3GPa, Feed speed : 30.9m/min, Depth of workpiece : 10cm
 DFRS : Difference in the maximum and minimum revolution speed of band saw wheel during sawing
 DPRS : Depression of the revolution speed of band saw wheel during sawing
 NPC : Net power consumption

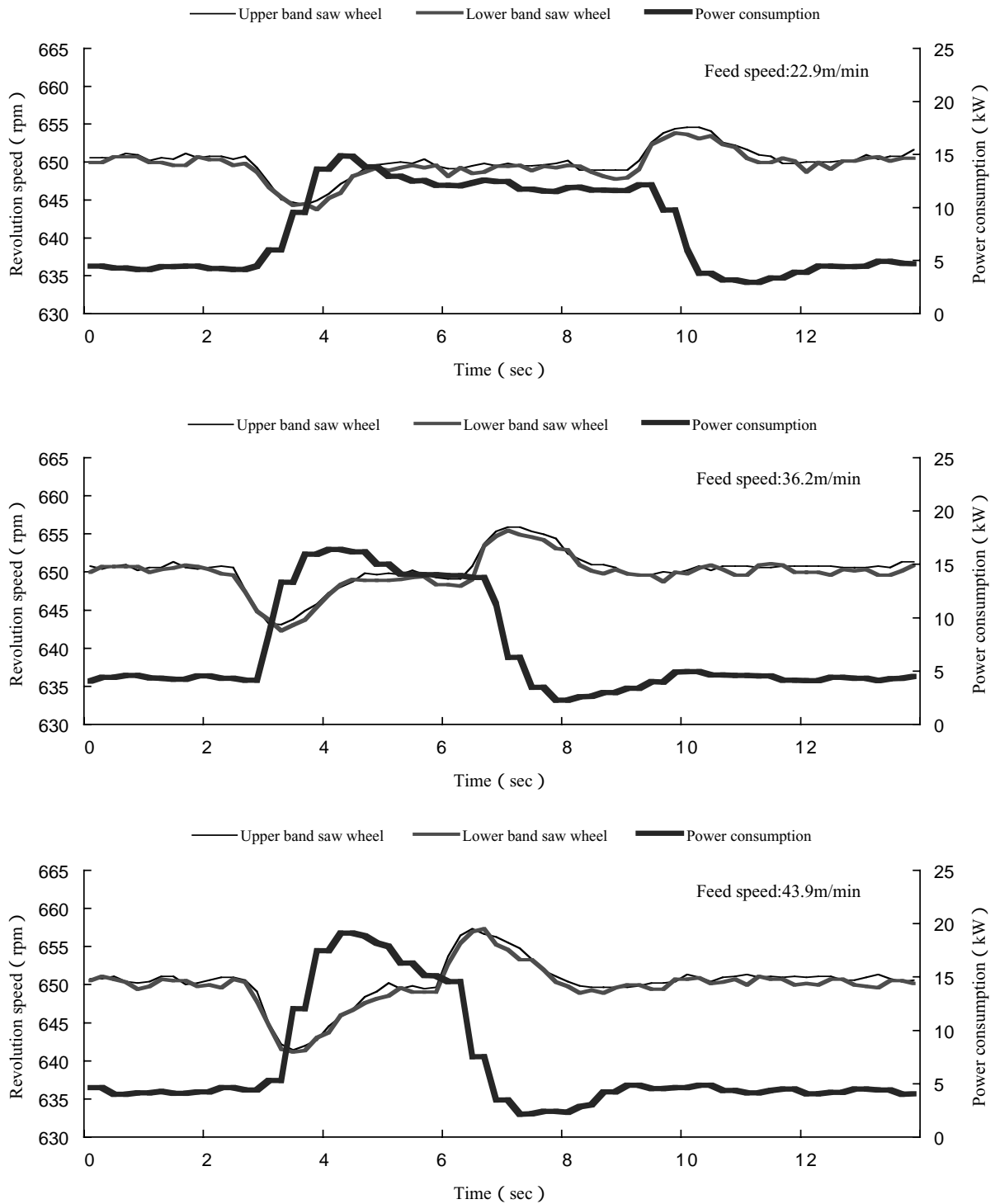

Fig.3. Behavior of revolution speeds of band saw wheels and power consumption at each feed speed.
 Saw strain : 81.3GPa, SPRS : 650rpm, Depth of workpiece : 10cm

increase temporarily.

The inverter is installed on the main motor of the band mill used in order to keep the revolution speed constant. When the revolution speed of the main motor decreases, the inverter acts to keep the revolution speed at the set point, i.e. it flows the electric current more. This may be a reason that the revolution speeds of band

saw wheels decrease and then resume to the SPRS level during sawing. After finish of sawing, the revolution speed of the main motor increases because the electric current still flows much as sawing level through main motor for a while, so that the electric current is decreased by the inverter. The electric current may be decreased to less than idling level when the revolution speed of the

main motor reaches at the set point; consequently, the power consumption is temporarily lower after sawing than during idling.

3.2. Influence of feed speed

As shown in Fig.2, the difference in the maximum and minimum revolution speeds of band saw wheel during sawing is abbreviated to DFRS, the depression of the revolution speed of band saw wheel during sawing to DPRS, and the net power consumption during sawing to NPC, in this paper.

The relationship between feed speed and DFRS at different saw stains is shown in Fig.4. The DFRS increased with an increase in feed speed. In general, sawing force increases with an increase in feed speed, since feed per tooth, namely cutting stock, increases with an increase in feed speed. It is thought the greater the sawing force, the greater the braking effect is. The DFRS shown in Fig.4 increased with an increase in feed speed at each saw strain.

Table 2 shows the DPRS rate (ratio of DPRS to SPRS) at each feed speed. In the case of the sawing 10

cm thick lumber of Malas, the DPRS rate ranged from 0.009 to 0.02. These values are smaller than 5% shown in the former study (Yamaguchi and Mori, 1957). Although we can not easily compare these results because the sawing conditions are different, it is thought that the DPRS rate was smaller in this study since the main motor of the band mill used had an enough power to saw 10 cm thick lumber of Malas under this experimental condition. This table indicates that the DPRS rate has a tendency of decreasing with an increase in SPRS. One of the reasons thought is that the feed per tooth decreases with an increase in SPRS. Another reason may be because the higher the SPRS, the greater the revolution energy of band saw is.

Fig.5 shows the relationship between feed speed and NPC. The NPC increased with an increase in feed speed. The load acting on the band saw increased with an increase in feed speed, so that the DFRS and the NPC increased with an increase in feed speed. The influence of the saw strain on the DFRS was not evident under the experimental conditions in this study.

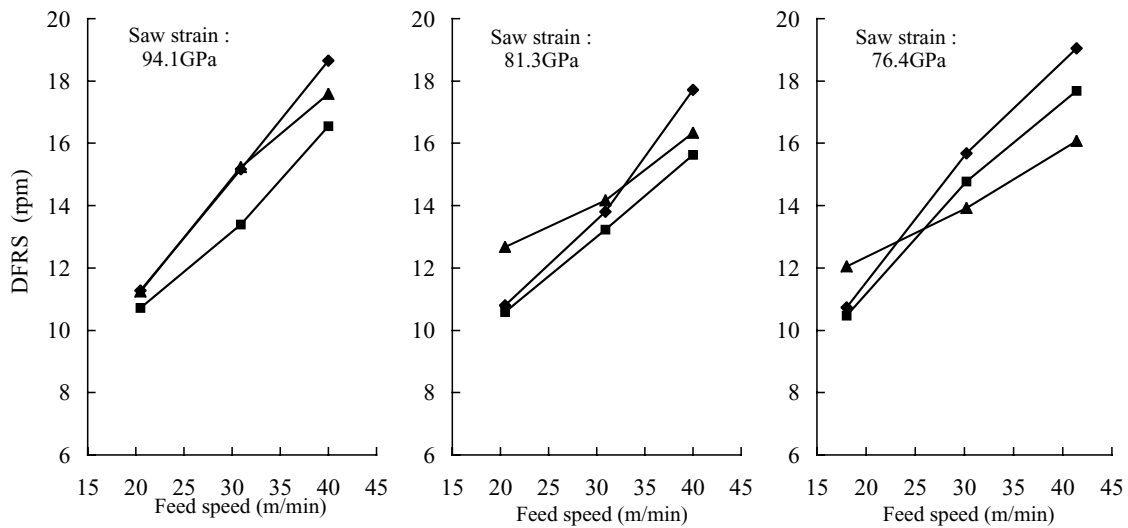

Fig.4. Relationship between feed speed and DFRS of the upper band saw wheel.
SPRS : 550rpm, 650rpm, 750rpm

Table 2. DPRS rate at each feed speed.

SPRS \ Feed Speed	Saw strain of 94.1 GPa			Saw strain of 81.3 GPa			Saw strain of 76.4 GPa		
	550 rpm	650rpm	750rpm	550rpm	650rpm	750rpm	550rpm	650rpm	750rpm
22.9 m/min	0.011	0.009	0.010	0.011	0.009	0.010	0.012	0.010	0.009
36.2 m/min	0.016	0.013	0.011	0.015	0.011	0.011	0.016	0.012	0.012
43.9 m/min	0.020	0.016	0.013	0.018	0.014	0.013	0.020	0.014	0.014

Depth of workpiece : 10cm, DPRS rate = DPRS/SPRS

3.3. Influence of depth of workpiece

Fig.6 shows the relationship between depth of workpiece and DFRS. This figure indicates that the higher the depth of workpiece, the lower the SPRS, and the faster the feed speed, the greater the DFRS is. The load acting on the band saw increases with an increase in depth of workpiece, since the number of teeth in the workpiece during sawing increases with an increase in depth of workpiece. During sawing, 1 or 2 teeth were in the workpiece in the case of depth of workpiece of 5 cm ($50/32=1.5625$), 3 or 4 teeth were in the case of 10 cm ($100/32=3.125$), and 4 or 5 teeth were in the case of 15 cm ($150/32=4.6875$). The DFRSs were especially great at feed speeds of 36.2 and 43.9 m/min and depth of workpiece of 15 cm, in the case of SPRS of 550 rpm.

The DFRS was also especially great at feed speed of 43.9 m/min and depth of workpiece of 15 cm, in the case of SPRS of 650 rpm. The DPRS rate for each depth of workpiece is shown in Table 3. The DPRS rates were also especially great under these conditions. It is thought that the amounts of cutting stock per tooth were too large to hold the sawdust in the gullets, so that the DFRSs and DPRS rates were especially great under these conditions.

Since the wood removed per tooth is an important factor in saw performance, the ratio of wood removed per tooth to gullet volume is a useful index of operating conditions and may be called as the Gullet Feed Index (GFI) (Reineke, 1956). The GFI is calculated by Equation (1).

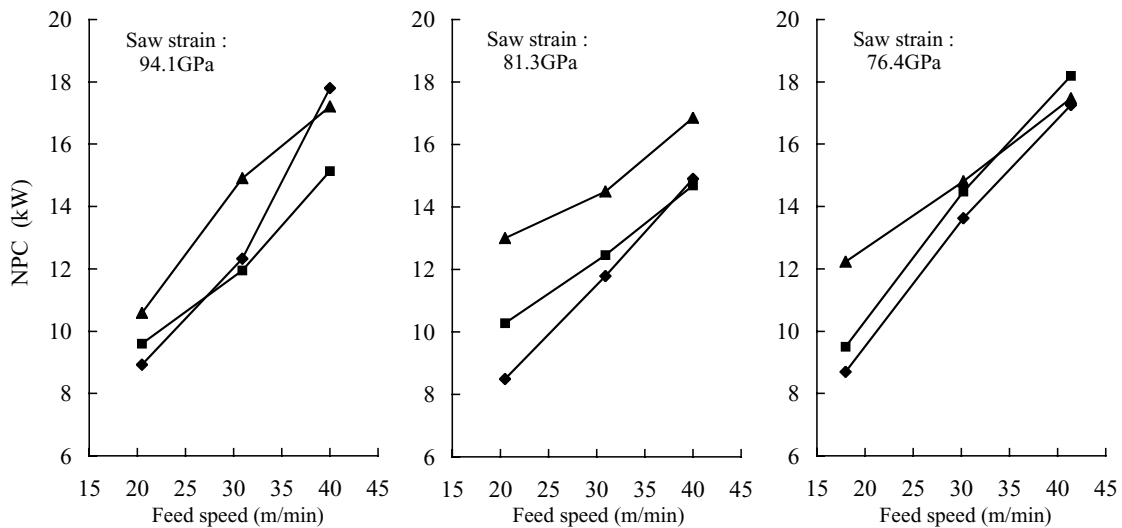

Fig.5. Relationship between feed speed and NPC.
Depth of workpiece : 10cm
SPRS : 550rpm, 650rpm, 750rpm

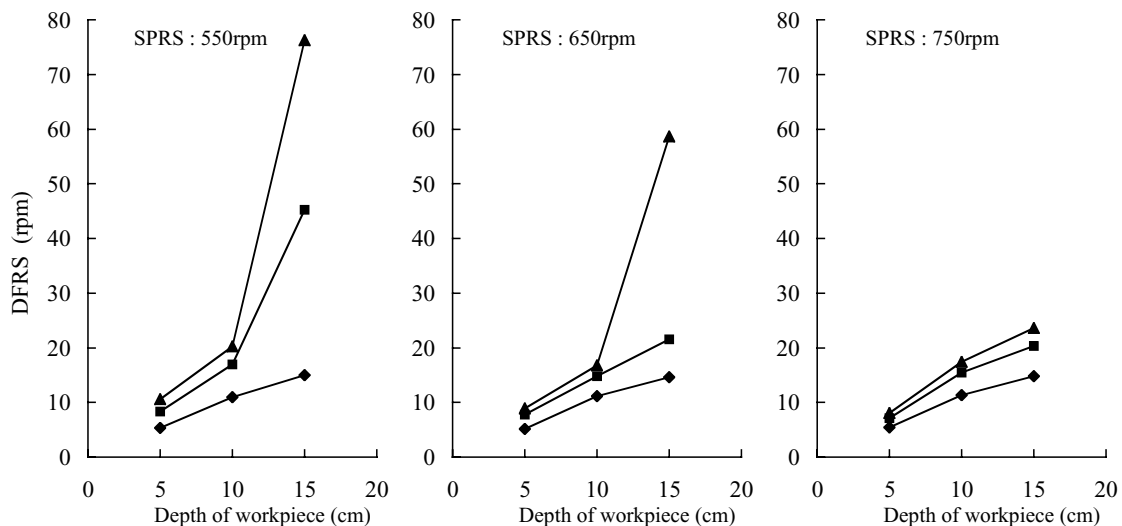

Fig.6. Relationship between depth of workpiece and DFRS of the upper band saw wheel.
Feed speed : 22.9m/min, 36.2m/min, 43.9m/min
Saw strain : 81.3GPa

Table 3. DPRS rate at for each depth of workpiece.

Depth of workpiece	SPRS	Feed speed of 22.9 m/min			Feed speed of 36.2 m/min			Feed speed of 43.9 m/min		
		550 rpm	650rpm	750rpm	550rpm	650rpm	750rpm	550rpm	650rpm	750rpm
5 cm		0.005	0.005	0.004	0.008	0.007	0.006	0.010	0.008	0.006
10 cm		0.012	0.009	0.009	0.018	0.012	0.012	0.021	0.015	0.013
15 cm		0.016	0.013	0.012	0.066	0.019	0.015	0.125	0.077	0.019

Saw strain : 81.3GPa

Table 4. Calculated gullet feed index (GFI).

Depth of workpiece	Feed Speed	SPRS of 550rpm			SPRS of 650rpm			SPRS of 750rpm		
		5cm	10cm	15cm	5cm	10cm	15cm	5cm	10cm	15cm
22.9 m/min		0.11	0.22	0.33	0.09	0.19	0.28	0.08	0.16	0.24
36.2 m/min		0.17	0.35	0.52	0.15	0.29	0.44	0.13	0.25	0.38
43.9 m/min		0.21	0.42	0.63	0.18	0.36	0.53	0.15	0.31	0.46

Saw strain : 81.3GPa

$$GFI = \frac{fdk}{ad} = \frac{fk}{a} \tag{1}$$

where, *f* is the feed per tooth, *d* is the depth of workpiece, *k* is the kerf width, and *a* is the area of the gullet. Table 4 shows the calculated GFI. In the case of depth of workpiece of 15 cm, the GFIs exceeded 0.50 at feed speeds of 36.2 and 43.9 m/min with SPRS of 550 rpm and at feed speed of 43.9 m/min with SPRS of 650 rpm.

In general, the volume bulks when the solid wood is converted into the sawdust. The ratio between sawdust bulk volume and solid wood volume can be denoted as "bulking factor". For specified sawing conditions,

multiplying the GFI by the "balking factor" will give the true proportion of maximum capacity used (Reineke, 1957). If multiplying the GFI by the "bulking factor" exceeds 1, the amount of sawdust exceeds the capacity of the gullet and the sawdust overflows from the gullet. Although it is not sure how much is the "bulking factor" for the sawing in this study, it is assumed that the amount of sawdust exceeds the capacity of the gullet because the DFRSs and DPRS rates were especially great at feed speeds of 36.2 and 43.9 m/min with SPRS of 550 rpm and at feed speed of 43.9 m/min with SPRS of 650 rpm.

Fig.7 shows the relationship between depth of workpiece and NPC. The NPC increased with an

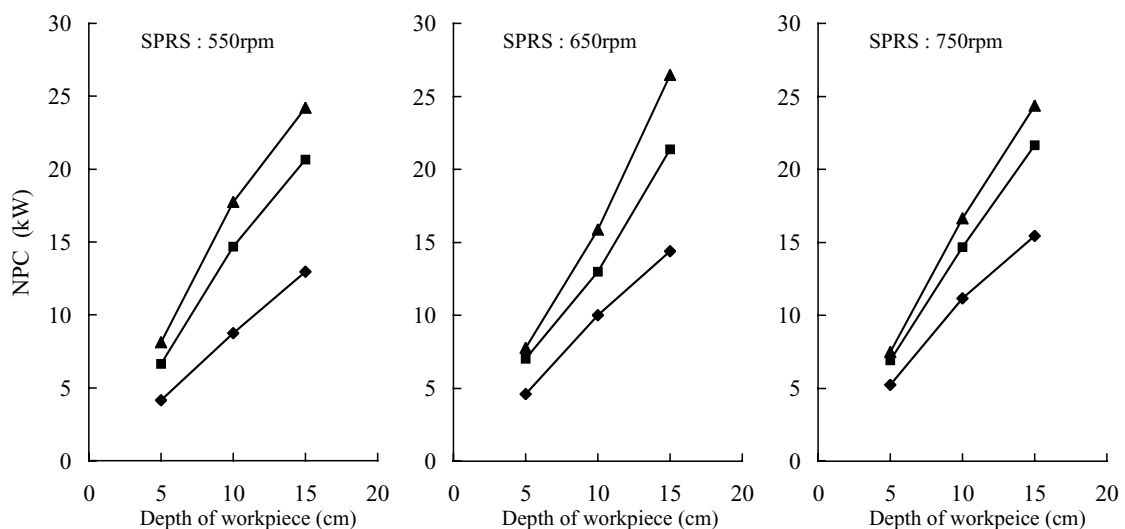

Fig.7. Relationship between depth of workpiece and NPC.
 Feed speed : 22.9m/min, 36.2m/min, 43.9m/min
 Saw strain : 81.3GPa

increase in depth of workpiece. When the workpiece, depth of workpiece of 15 cm, was sawn at feed speeds of 36.2 and 43.9 m/min with SPRS of 550 rpm or at feed speed of 43.9 m/min with SPRS of 650 rpm, the DFRSs were especially great as mentioned above; on the other hand, the NPCs were not especially great. This result may indicate that the overloading on the band saw did not begin under these conditions although the amount of sawdust exceeds the capacity of the gullet.

4. Conclusions

The revolution speeds of the band saw wheels were measured precisely during sawing. The revolution speed decreased along with the start of sawing and then resumed the idling revolution speed level. It increased immediately after sawing, and then it resumed to the idling revolution speed level before sawing. The power consumption increased rapidly simultaneous with the start of the sawing and then it gradually decreased. After sawing, the power consumption decreased rapidly and then resumed the idling power consumption level. The load acting on the band saw increased along with the start of the sawing; consequently, the revolution speeds decreased and the net power consumption increased. The DFRS increased with an increase in feed speed because the load acting on the band saw increased with an increase in feed speed. The DPRS rate tended to

decrease with an increase in SPRS. The DFRS increased with an increase in depth of workpiece and was especially great under several conditions; where the load acting on the band saw was thought to increase since the amount of sawdust exceeds the capacity of the gullet.

References

- Konishi, C. and Yamaguchi, K. (1978) Cutting force and required net power in band sawing, *Wood Industry*, **33** (10), 20-22
- Murata, K., Fujiwara, K., and Nishimura, K. (1993) Sawing Performances of Band Saws Treated with New Filing Methods II, *Mokuzai Gakkaishi*, **39** (11), 1239-1245
- Reineke, L. H. (1956) Sawing rate, sawdust chambering, and spillage, *Forest Prod. J.*, **6**, 348-354
- Reineke, L. H. (1957) Factor affecting saw capacity, *Forest Prod. J.*, **7**, 235-238
- Sugihara, H. (1954A) A Study on the Power Requirements for No Load Running of Bandsaw Machine, *Wood Research*, **10**, 199-205
- Sugihara, H. (1954B) Studies on Wood-sawing by Bandsaw-blade (2nd Report), *Wood Industry*, **19** (12) 29-32
- Yamaguchi, K. and M. Mori (1957) Cutting Speed for Band Re-Saw, *Mokuzai Gakkaishi*, **3**, 177-182

挽き材中の帯鋸鋸車回転数と消費電力の変化

村田 光司^{1)*}・伊神 裕司¹⁾・藤原 勝敏¹⁾

要 旨

帯鋸盤の鋸車の回転数は、挽き材時に帯鋸に負荷がかかることにより変化するといわれている。しかし、挽き材時における帯鋸鋸車回転数の変化に関する研究はほとんどなされていない。本研究では、帯鋸鋸車回転数をロータリーエンコーダにより精密に測定し、挽き材中の帯鋸鋸車回転数の変化を検討した。また、帯鋸盤主軸モータの消費電力の変化についても検討を加えた。帯鋸鋸車回転数は、挽き材が開始されるとすぐに減少し、その後空転のレベルまで戻り、挽き材終了と同時に増加した後、空転のレベルに復帰した。帯鋸盤の主軸モータの消費電力は、挽き材開始と同時に急激に増加した後、緩やかに減少し、挽き材終了と同時に急激に減少して、空転のレベルに復帰した。帯鋸鋸車回転数の挽き材中の最大値と最小値の差は、送り速度の増加および挽き幅の増加に伴い増加した。

キーワード：帯鋸、帯鋸鋸車、回転数、消費電力、回転数変化

* 森林総合研究所 加工技術研究領域 〒305-8687 稲敷郡茎崎町松の里 1 e-mail:saw@ffpri.affrc.go.jp

1) 森林総合研究所 加工技術研究領域